

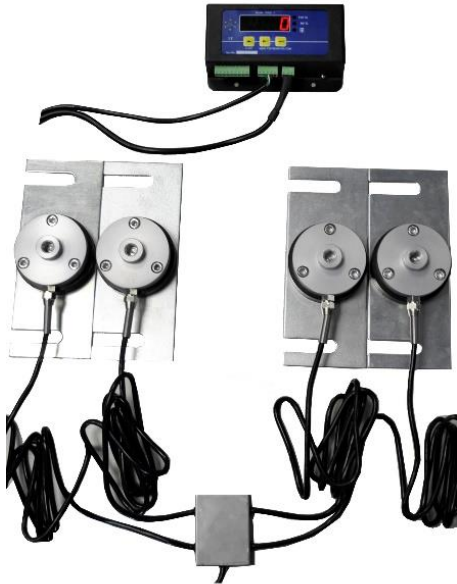

Quick start manual

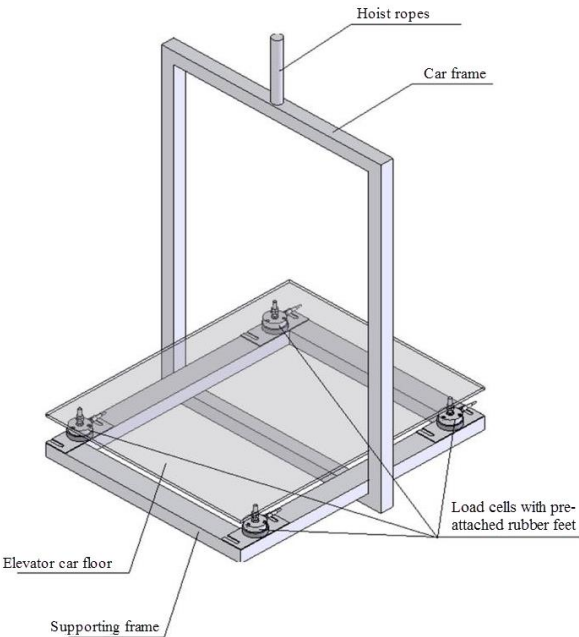

Quick start manual for EWS-1

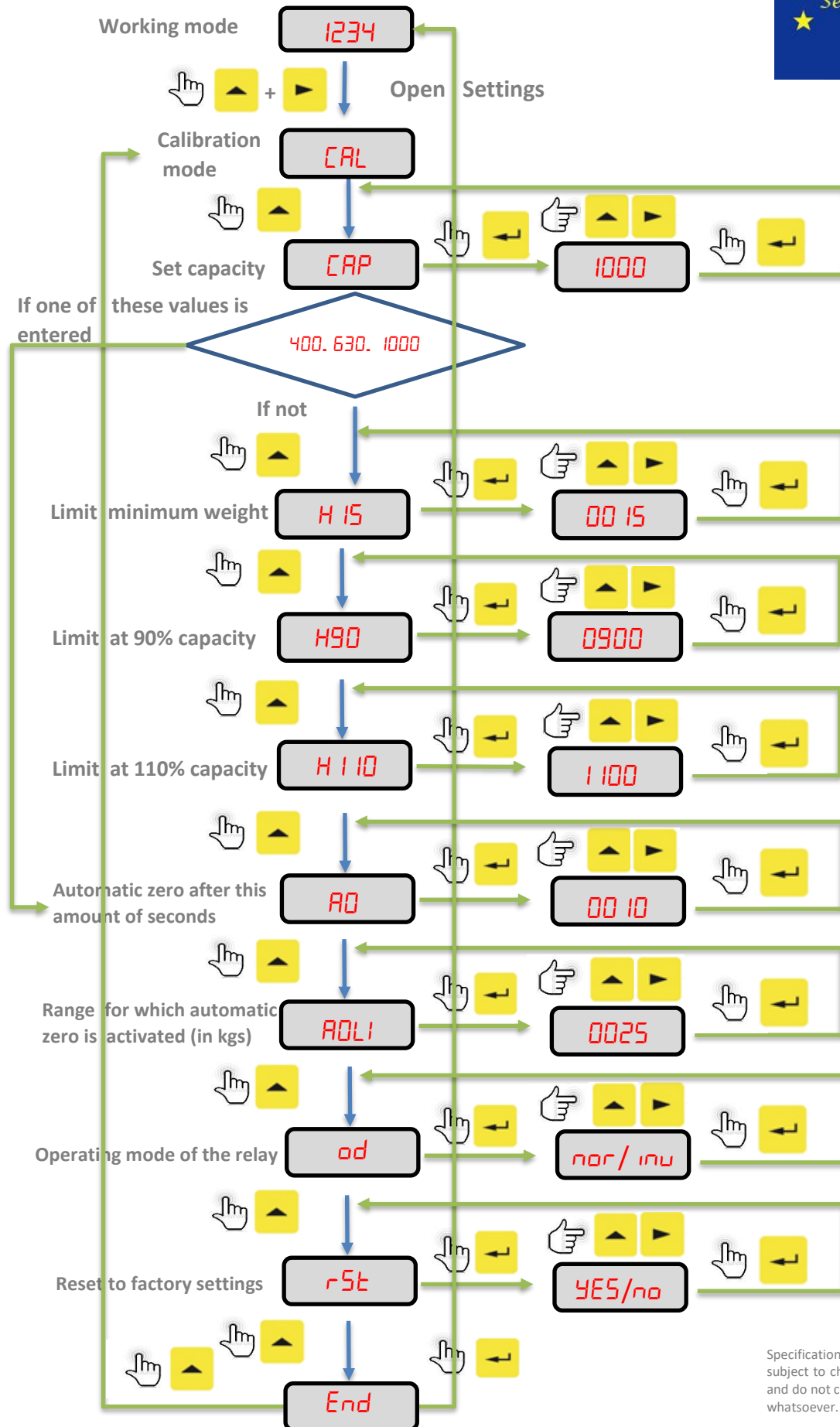

Quick start manual for EWS-1







To reset the weight of an empty cabin

In work mode  press  to tare.

Turning off the display

In work mode  press  to turn the display off.



Enter the service menu

In work mode  press  +  to enter the Settings 

In the settings menu:





The button  provides a choice between the different settings in the menu.

The button  makes you select a setting and confirm changes.



In the edit menu the  button makes you select a digit and  makes you change it. Press the  button to confirm the changes made.

Settings



Set capacity (min 0kg max 5000kg)

In work mode  press  +  to enter the Settings 

Press  until you see  then press  to enter the edit menu.

When in the edit menu use the  and  button to set the right capacity. Then press  button to confirm the changes made.

Set limit minimum weight (min 0kg max 50kg)

In work mode  press  +  to enter the Settings 

Press  until you see  then press  to enter the edit menu.





When in the edit menu use the  and  button to set the right capacity.

Then press  button to confirm the changes made.

Quick start manual for EWS-1







Set limit at 90% capacity (min 0kg max 5000kg)

In work mode  press  +  to enter the Settings 



Press  until you see  then press  to enter the edit menu.

When in the edit menu use the  and  button to set the right capacity. Then press  button to confirm the changes made.

Set limit at 110% capacity (min 0kg max 5000kg)

In work mode  press  +  to enter the Settings 



Press  until you see  then press  to enter the edit menu.

When in the edit menu use the  and  button to set the right capacity. Then press  button to confirm the changes made.

Set automatic zero after this amount of seconds (min 0 max 60 second)

In work mode  press  +  to enter the Settings 



Press  until you see  then press  to enter the edit menu.

When in the edit menu use the  and  button to set the right time. Then press  button to confirm the changes made.

Set range for which automatic zero is activated (min 5kg max 50kg)

In work mode  press  +  to enter the Settings 

Press  until you see  then press  to enter the edit menu.

When in the edit menu use the  and  button to set the right capacity. Then press  button to confirm the changes made.





Setup operating mode of the relay (normal inverse)

In work mode  press  +  to enter the Settings 

Press  until you see  then press  to enter the edit menu.

Quick start manual for EWS-1







When in the edit menu use the  button to set either  or  for either the normal or inversed mode of the relays. Then press  button to confirm your choice.

Inverse mode							
Normally closed				Normally open			
	15	90	110		15	90	110
No power	1	1	1	No power	0	0	0
There is a power, level is not reached	0	0	0	There is a power, level is not reached	1	1	1
Limit passenger	1	0	0	Limit passenger	0	1	1
Limit 90%	1	1	0	Limit 90%	0	0	1
Limit 110%	1	1	1	Limit 110%	0	0	0

Normal mode							
Normally closed				Normally open			
	15	90	110		15	90	110
No power	1	1	1	No power	0	0	0
There is a power, level is not reached	1	1	1	There is a power, level is not reached	0	0	0
Limit passenger	0	1	1	Limit passenger	1	0	0
Limit 90%	0	0	1	Limit 90%	1	1	0
Limit 110%	0	0	0	Limit 110%	1	1	1

Reset to factory setting

In work mode  press  +  to enter the Settings 

Press  until you see  then press  to enter the edit menu.

When in the edit menu use the  button to set either  or  to either

confirm the reset or not. Then press  button to confirm your choice.

Reset values:

Parameter	Value
Calibration weight	0kg
Rated capacity	400kg
periodicity auto zero of gained weight	2sec.
Range of zero gained weight	15kg
Operating mode of the relay	Inverse

Specifications and dimensions are subject to change without notice and do not constitute any liability whatsoever.

Quick start manual for EWS-1



END

Press  until you see  then press  to leave the settings menu.

When you want to stay in the settings menu press the  button to go back to 

Calibration

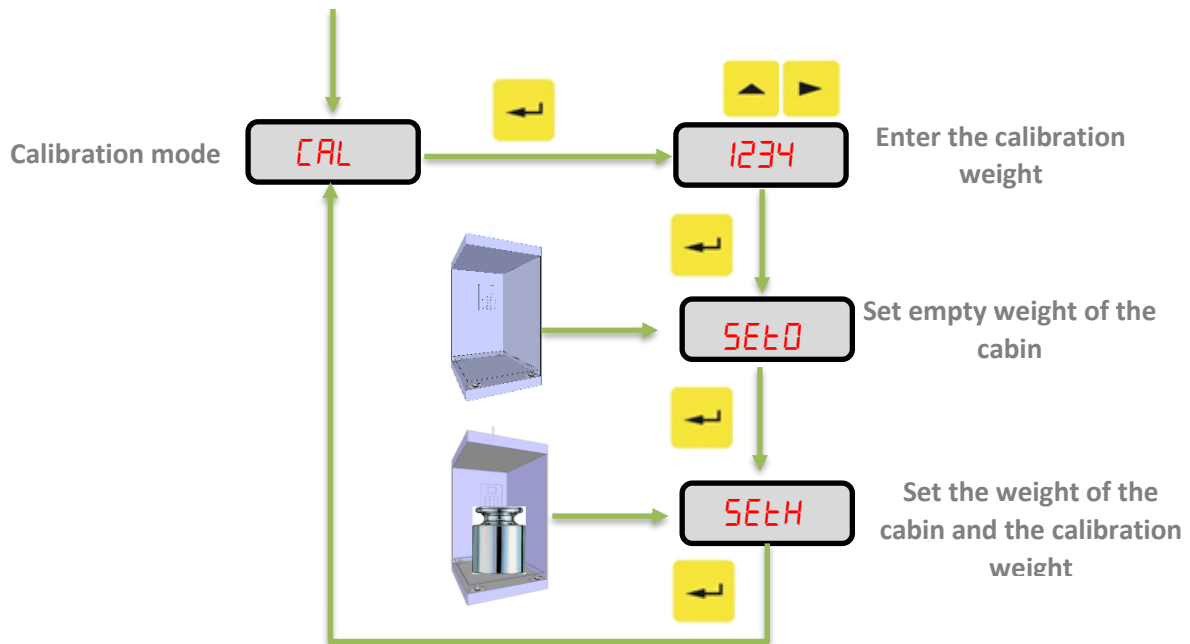

For calibration prepare the **calibration weight which is between 20% and 50% of the lift capacity.**

In work mode  press  +  to enter the Settings .

Now press the  button to enter the calibration menu.

In the calibration menu use the  and  button to set the calibration weight. Then press 

button to confirm the changes made. Now you should see the  setting.

Now press the  button to enter the empty weight setting. Make sure the elevator is empty and

press the  button to confirm. Now you should see the  setting.

Now press the  button to enter the weight of the calibration weight and the cabin together. Make

sure the elevator is loaded with the calibration weight and press the  button to confirm.

You have now successfully calibration the Elevator weighing system.

Specifications and dimensions are subject to change without notice and do not constitute any liability whatsoever.