

HC51x Series Indicator



Technical Instruction Manual

Table of Contents

1 Introduction 1

- 1.1 Warnings 1
- 1.2 Features..... 1
- 1.3 Options..... 1
- 1.4 Functions..... 2
- 1.5 Specifications..... 2

2 Installation 3

- 2.1 Dimensions..... 3
- 2.2 Keypad..... 4
- 2.3 Annunciator..... 4
- 2.4 Interface 4

3 Configuration 5









- 3.1 User Configuration 5
 - 3.1.1 Zero..... 5
 - 3.1.2 Capacity 5
- 3.2 System Configuration..... 5
 - 3.2.1 Display Unit 5
 - 3.2.2 Pre-caution Weight 6
 - 3.2.3 Warning Weight 6
 - 3.2.4 Cut-off Weight..... 6
 - 3.2.5 Zero-tracking Time 6
 - 3.2.6 Zero-tracking Range 7
 - 3.2.7 Output Mode..... 7
 - 3.2.8 System Reset 7
- 3.3 Calibration 8
- 3.4 0-10V Adjustment (optional) 9

 Please read this manual carefully before operating the indicator.

1 Introduction

1.1 Warnings

Failure to heed these warnings may result in serious injury or even death.

-  DO NOT allow children or inexperienced persons to operate the indicator.
-  DO NOT operate without all shields and guards in place.
-  DO NOT step on the unit.
-  DO NOT place fingers into slots or possible pinch points.
-  DO NOT use the indicator if any of the components are cracked.
-  DO NOT exceed the rated load limit of the indicator.
-  DO NOT make alterations or modifications to the indicator.
-  DO NOT use near water.

Before opening the indicator, ensure the power cord is disconnected from the outlet.

1.2 Features

- High resolution analog-to-digital conversion
- Carbon steel enclosure for rigid EMC environment
- 4-digit 7-segment alphanumeric LED display
- 3 high reliable relays of 10A contact rating
- 3 LED annunciators for relay status
- Drives up to 12pcs 350Ω loadcells
- Industrial protection with resettable fuse
- Automatic zero-tracking

1.3 Options

- 4~20mA current-loop analog output (A)
- CAN bus communication(C)
- Cabin door signal input (H)
- 4th relay for motor control or 50%F.S. set-point (R)
- 0-10V analog output (V)

1.4 Functions

Load	Normal Close Relay n						Annunciator		
	OUT = normal (default)			OUT = inverse			1	2	3
	1	2	3	1	2	3			
power-off	Close	Close	Close	Close	Close	Close	Off	Off	Off
< H15 Weight	Close	Close	Close	Open	Open	Open	Off	Off	Off
>= H15 Weight	Open	Close	Close	Close	Open	Open	On	Off	Off
>= H90 Weight	Open	Open	Close	Close	Close	Open	On	On	Off
>= H110 Weight	Open	Open	Open	Close	Close	Close	On	On	On

1.5 Specifications

Analog Performance

Full Scale Input Signal	-11.7 ~ +11.7 mV (-3.9 ~ +3.9 mV/V)
Loadcell Excitation Voltage	3.0 ±3% Vdc (typ.)
Number of Loadcells	12 x 350Ω / 16 x 700Ω
0-10V Output Load (optional)	500 Ω (max.)
0-10V Output Linearity (optional)	±0.5 %F.S.

Metrology Performance

Cut-off Range	110 %F.S. (dft.)
Warning Range	90 %F.S. (dft.)
Half Range	50 %F.S. (dft.)
Pre-caution Range	15 kg (dft.)
Manual-Zero Range	100 %F.S.
Zero-tracking	-100~5 kg/s

User Interface

Display	4-digit LED, 0.56inch/14.2mm 7-segment
Annunciators	Overload, Caution, Pre-caution
Keypad	3-key flat tactile switch

Relays

Number of Relays	3 or 4 (optional)
Contact Materials	AgSnO ₂ , AgCdO
Contact Resistance	100 mΩ (1 A / 6 Vdc)
AC Contact Ratings	10 A / 277 Vac
DC Contact Ratings	10 A / 28 Vdc

Coil Power at Pickup Voltage	2770 VA / 210 W (typ.)
Insulation Resistance	1000 MΩ (500 Vdc)
Contact to Coil Dielectric Strength	1500 Vac (1min.)
Open Contacts Dielectric Strength	750 Vac (1min.)
Electrical Life	10 ⁵ operations (typ.)
Mechanical Life	10 ⁷ operations (typ.)

Power Supply

Power Supply	HC510: 230 Vac +/-10% / 50~60Hz	HC512: 24Vdc +/-10%
Fusing	1.10 A resettable	
Power Consumption	6 W (max.)	

Environmental

Operating Temperature	-10 ~ +40 °C (+14 ~ +104 °F)
Storage Temperature	-20 ~ +50 °C (-4 ~ +122 °F)
Operating Humidity	0 ~ 90 % at 20 °C (rel.)

Enclosure

Enclosure Material	Carbon Steel
Indicator Net Weight	0.60 kg (1.32 lbs.)
Enclosure Dimensions	14.0 x 9.6 x 4.0 cm (5.5 x 3.8 x 1.6 inch)

2 Installation

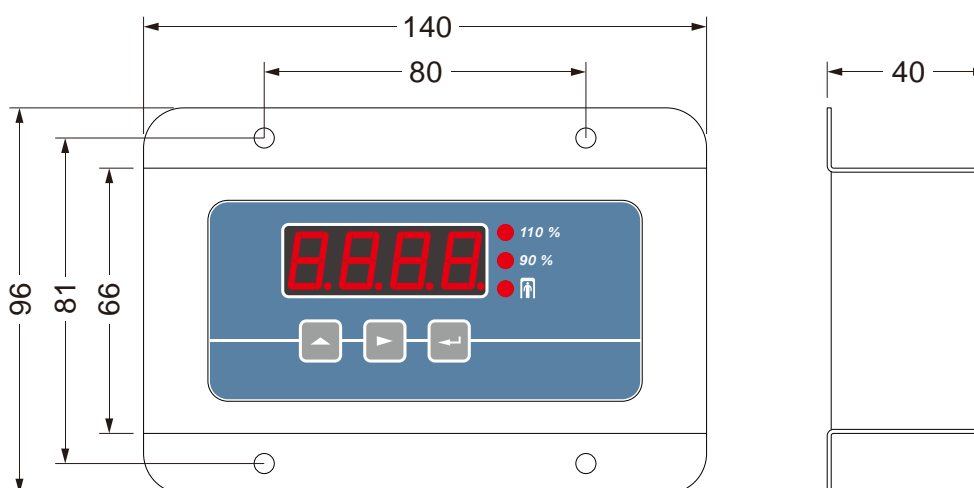

2.1 Dimensions





Dimensions in Millimeters

Specifications and dimensions are subject to change without notice and do not constitute any liability whatsoever.

2.2 Keypad

	Up	Increase blinking digit
	Right	Move blinking digit right
	Enter	Confirm and go to next

2.3 Annunciator

 110 %	Light on when load is over 110%F.S (by default)
 90 %	Light on when load is over 90%F.S (by default)
 15kg	Light on when load is over 15kg (by default)

2.4 Interface

Standard version:

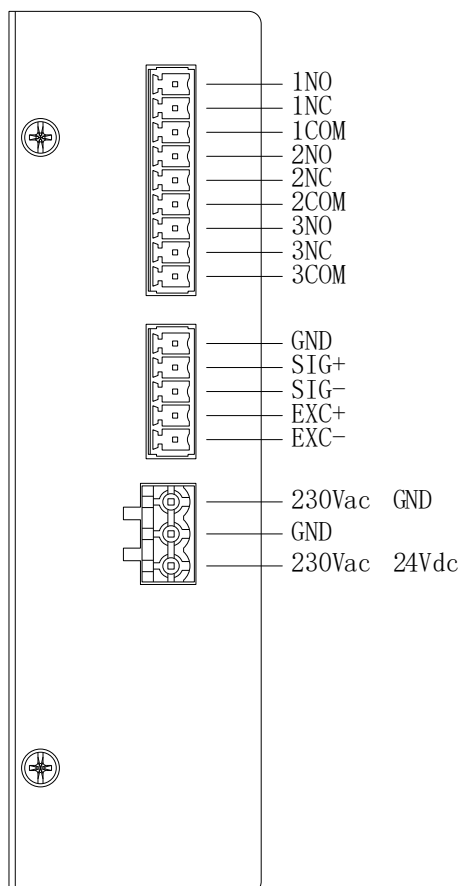

Optional additional connections:

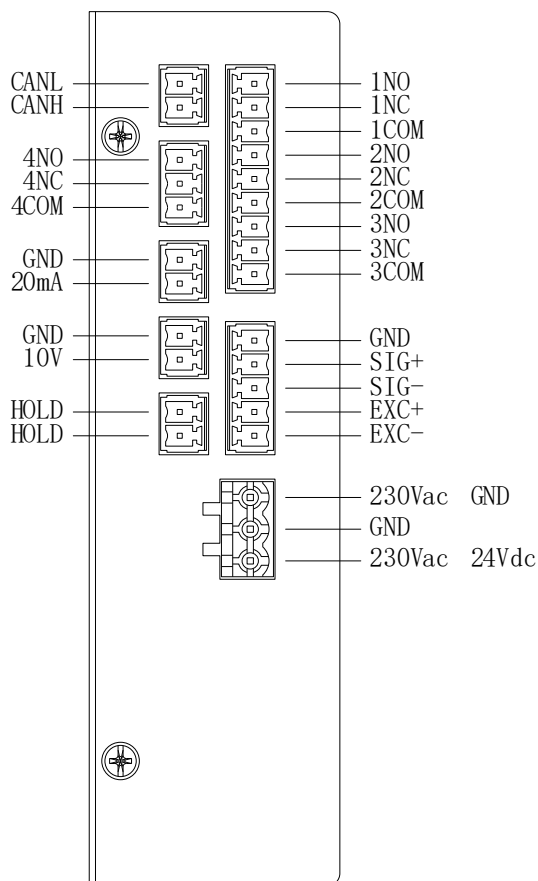



NO: Normal Open; NC: Normal Close

3 Configuration

3.1 User Configuration

In Normal/Work Mode

Press  and  at the same time for 1 sec. to enter User Configuration.

3.1.1 Zero

Zero function takes out the system deviations in zero when needed.

When  shows.

Press  to perform zero.

Indicator will count down in 10 seconds to wait for operator to leave the cabin.

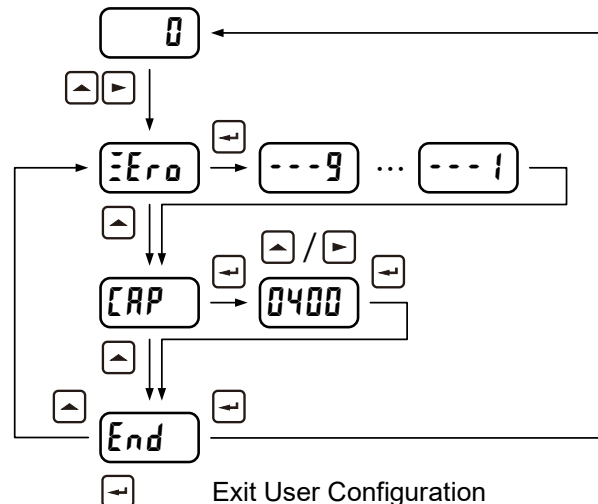

3.1.2 Capacity

When  shows.

Press  to increase blinking digit, press  to move blinking digit right.



Input the rated capacity of the lift system, in kg unit.

Press  to confirm.

When  shows, press  to return to normal mode.

3.2 System Configuration

In User Configuration

When  shows, press  and  at the same time for 1 sec. to enter password mode. Please refer to the diagram on the next page.



In Password Mode

Press  to increase blinking digit, press  to move blinking digit right. Input Password.

Press  to confirm password (0258) and enter sub menu.

3.2.1 Display Unit

Display Unit defines the system's weight unit on the LED display.

If  is selected, the weight reading is in kg unit. For example,  means 1055 kg.

If  is selected, the weight reading is in t(ons) unit.

The decimal point is always fixed and the unit t is always shown.

For example,  means 1.05t. After display Unit is configured, all the user-input will be changed to accommodate to the new display format.

3.2.2 Pre-caution Weight

Start Weight **H15** is the detection threshold against a light weight such as animal, infant, etc. Start Weight can be set from 0 to 50kg; by default it is set to 15kg.

When the load is greater than Start Weight,  lamp lights on
Relay 1 set.

3.2.3 Warning Weight

Warning Weight **H90** is the detection threshold for 90%F.S.

Warning Weight can be set from P15 to maximum system capacity*.

When the load is greater than Warning Weight,  **90 %** lamp lights on
Relay 2 set.

3.2.4 Cut-off Weight

Cut-off Weight **H110** is the detection threshold for 110%F.S.

Cut-off Weight can be set from P90 to maximum system capacity*.

When the load is greater than Cut-off Weight,  **110 %** lamp lights on
Relay 3 set.

3.2.5 Zero-tracking Time

The indicator's Zero-tracking function will enhance system temperature and drifting performance, if properly set.

Zero-tracking Time can be set from 0s to 180s.

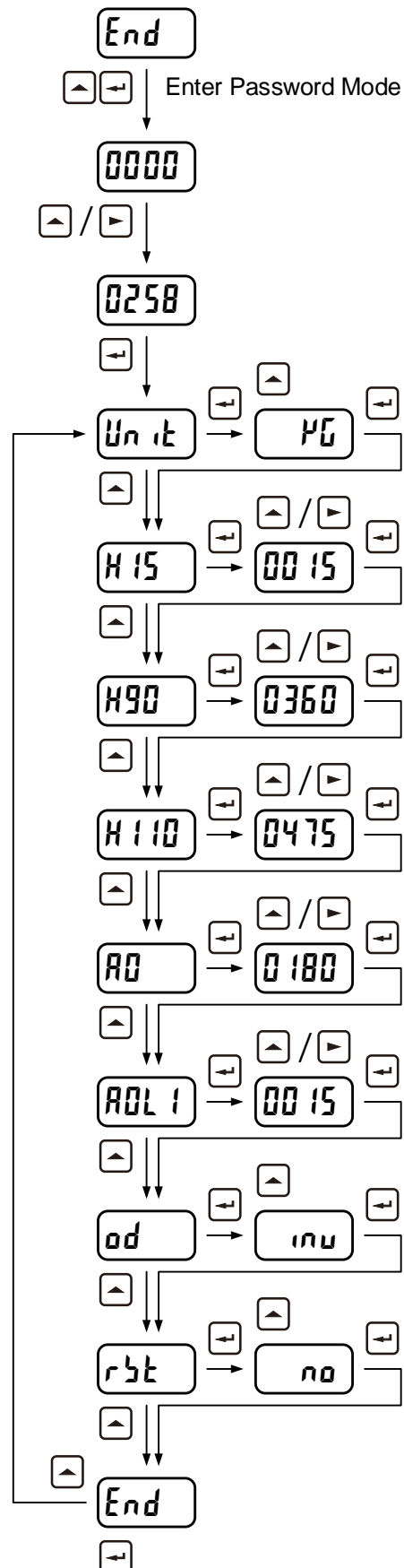

* = The maximum system's capacity is determined by the sum of the loadcells' capacity.

3.2.6 Zero-tracking Range

Zero-tracking Range can be set from 5kg to 50kg.

3.2.7 Output Mode

The three relays can be configured to work in 2 modes; normal logic mode and inverted logic mode.

In normal logic mode, relay works in NC way. When load is greater than set-point, the corresponding relay will open, otherwise it is closed.

In inverted logic mode, relay works in NO way. When load is greater than set-point, the corresponding relay will close, otherwise it is open.

3.2.8 System Reset

System Reset r5t is used to reset all configurable parameters to its default / their default value.



Item	Display	Note
Display Unit	Unit	Select unit. kg or t
15%FS Weight	H15	Input the 15% weight. Val ≤ 50kg
90%FS Weight	H90	Input the 90% weight. P15 ≤ Val ≤ max capacity*
110%FS Weight	H110	Input the 110% weight. P90 ≤ Val ≤ max capacity*
Zero-tracking Time	00	Input the tracking time. 0s ≤ Val ≤ 180s
Zero-tracking Range	00L1	Input the tracking range. 5kg ≤ Val ≤ 50kg
Relay Output Mode	od	Select output logic; NORmal (=dft.) / INVerted
System Reset	r5t	YES/NO

* = The maximum system's capacity is determined by the sum of the loadcells' capacity.



3.3 Calibration

To re-calibrate the lift system, prepare the calibration weight at 20%-50% of the lift's capacity.



In Normal/Work Mode

Press  and  at the same time for 1 second to enter menu.

Press  to go to **End**.

Press  and  at the same time for 1 second to enter password mode.

In Password Mode

Press  to increase blinking digit, press  to move blinking digit right. Input Password (8416).

Press  to confirm password and enter calibration.

When **5E10** shows, make sure the lift cabin is empty (without any load).

Press  to start zero calibration.

Indicator will count down from 9 to 0.

During this 10 second count-down, the operator needs to walk out of the cabin.

When **400** shows, apply the calibration weight.

Press  to increase blinking digit, press  to move blinking digit right.

Input weight value.

Press  to start weight calibration.

Indicator will count down from 9 to 0.

During the 10 second count-down, the operator needs to walk out of the cabin also.

After **End** shows, the calibration is successfully done.

Press  to return to normal mode.

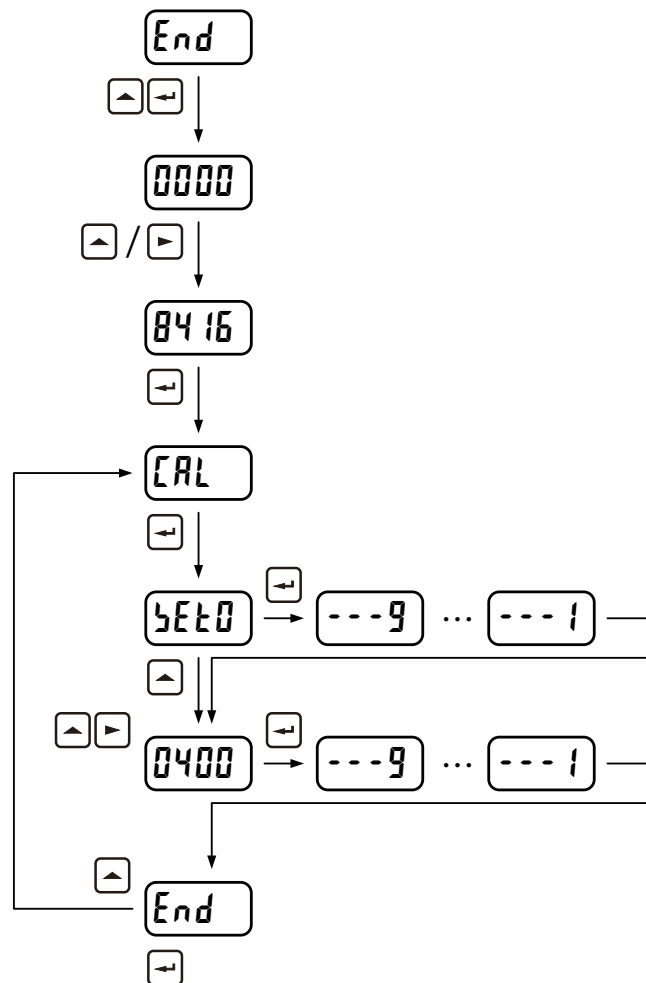





3.4 0-10V Adjustment (optional)

To adjust the indicator's output voltage, a voltmeter or multi-meter is needed.



Connect the output V+ terminal to voltmeter's positive pin (red cable), and connect the output GND terminal to voltmeter's negative pin (black cable).

During the power-up (display shows 8888).

Press  and  and  at the same time, and quickly release them, to enter the 10V adjustment mode.

The display shows .

The last 3-digit is the adjustment ratio, ranging from 000-999.

Press  to increase blinking digit, press  to move blinking digit right. Modify the ratio, to make the output voltage to be 10.0V.

Press  to confirm and exit.